

4G Trail Camera

Model:HC-900Pro

Live video & APP

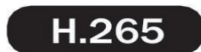

SPECIFICATIONS

Photo recording

Photo resolution	36 / 30 / 24 / 20 / 16 / 12 / 8 / 5 / 3 MP
File format	.JPG
Time lapse mode	5 / 30min , 1 / 2 / 3 / 6 / 12 / 24hour
Multi-shot mode	Up to 9 photos per detection
Stamp	Date, time, temperature (°C /°F)and moon phase
Capture mode	Camera / Video / Camera&Video / Time-lapse

Video recording

Video resolution	4K / 2K / 1080P / 720P / VGA
File format	.MP4 / H.26
Video length	5s / 10s / 30s / 60s / 90s
Capture mode	Colorful mode at daytime, black and white mode at night

Memory storage

Support	<ul style="list-style-type: none">• Internal memory: none• External memory: Micro SD card (up to 256GB, Not included)
---------	--

Viewing

Built-in screen	TFT 2.0”
-----------------	----------

Power source

Alkaline Battery	1.5V AA Battery*8
External Power Jack	DC 12V/1A(3.5x1.3mm)

Detection system

Motion Sensor	1 x PIR
Detection Angle	90°
Detection Range	Adjustable from 1 to 98 Ft
Trigger Speed	0.2second
Delay between each detection	1/5/10/30 seconds, 1/5/10/30 minutes

Night time illumination system

Infrat LEDs	44pcs LEDs
Flash Range	< 98 Ft
Exposure	Auto / 100 / 200 / 400

Optical field of view

120°

Dimensions

150mm x102mm x 70mm

Recommendations

Operating temperature	(-4°Fto + 158°F) (-20°C to + 70°C)
-----------------------	------------------------------------

Waterproof level

IP 66

THE BASICS

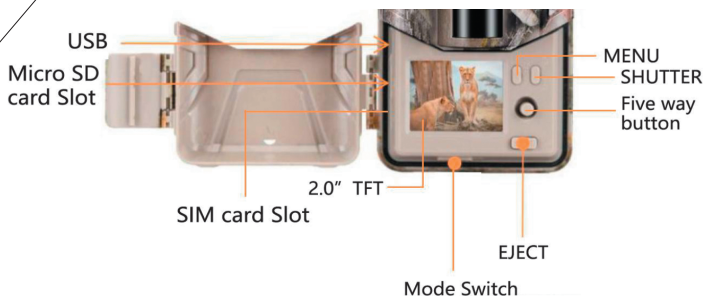

INSTALLATION

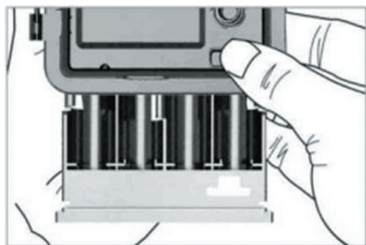

- ① Open the battery cover and insert 8 batteries(AA) following to the positive and the negative battery sign.



Close the battery cover to
Resist water and dust

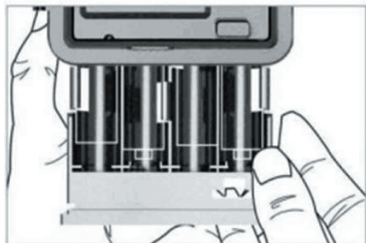

②

③

⚠️ WARNING

Be Sure to put AA batteries in the correct direction. Inserting batteries incorrectly will cause permanent damage.

Step 2

Insert Micro SD(Not included) memory card to Trail Camera.

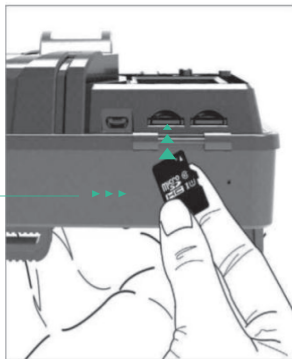

Step 3

Insert the sim card into the card slot after sim card is inserted turn on and check the left side of the screen.

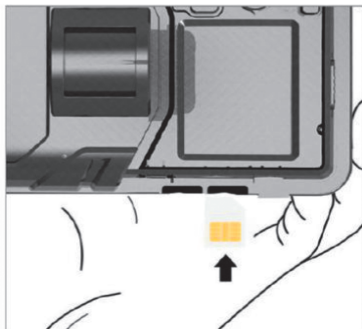

Step 4



① Slide the mode switch from **OFF** to **TEST** to activate the camera and view the user setup screen.

② And then slide the mode switch from **TEST** to **ON**.

③ The camera will start working after 10 seconds countdown, meanwhile the red indicator light will blink.

See if the signal grid is green, Green means receiving signal, White means signal reception failed.

Need to check if the sim card is locked.



Step 5

Scan the QR codes below [or](#) search for "SUNTEKCAM" on the Apple appstore [or](#) search for "SUNTEKCAM" on the Google Play to download the app.



App (iOS)



App (Android)

APP BINDING

1. How to check your ID and bind APP

1). Open your own machine menu interface and select Network
Click Device ID and the personal id of the machine will appear



2). Start the application, press + to scan the camera's quality check code and add the camera to your application. You can also click the scan item and manually enter the id

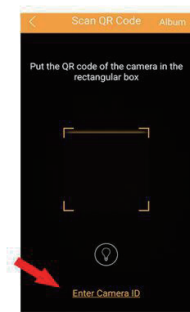
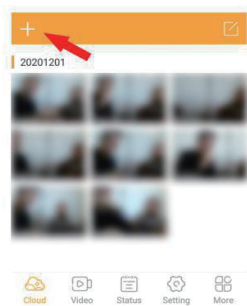

3).Fill in Device name, and password 123456 and press” submit
Then your camera is added into App successfully.After adding the device, remember to bind the sim card number in the settings. The area code is the number belonging to your area

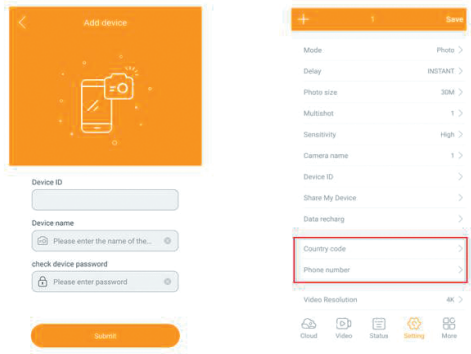

3.How to get pictures and videos ?

1).In” Video” submenu press” capture” then camera will get a command from App and capture a picture/video.

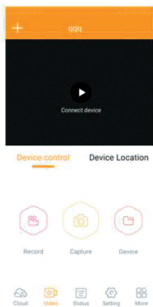

EXTERNAL POWER SUPPLY

Use 12V DC Power source (Not included)



OPERATING BUTTON



MENU Menu Button -- Menu Setting

SHUTTER Shutter Button -- Start/End Video Recording or Photo Taking

↑ Video Button – Video Recording Mode

↓ Camera Button -- Photo Mode

→ Replay Button -- Replay Mode

● OK Button

SETUP MENU

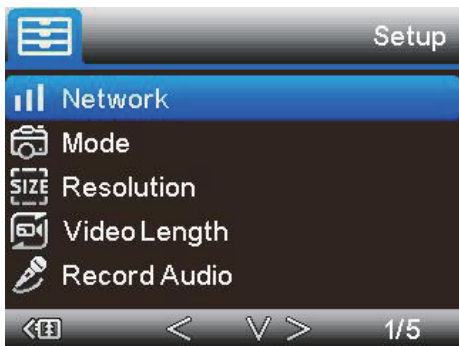

Setup	Sub Menu	Description
Mode	Camera,video,camera & video,Timelapse	Picture,video,picture and video,taking picture regular
Resolution	4K, 2K, 1080P, 720P, VGA	Video resolution
Video Length	5/10/30/60/90 seconds	Each Video max 90 sec, default 5 sec
Record Audio	On / Off	Video With Sound

Setup	Sub Menu	Description
Image Size	36/30/24/20/16/12/8/5/3MP	Image resolution
Interval	1/10seconds, 1/3/5/10/15/30minutes	Max 30 minutes delay
TimeLapse	5/30minutes, 1/2/3/6/12/24hour	Take pic every 5min
Sequcence	1/3/6/9 pictures	Max 9 pics one shot
ISO	Auto/100/200/400	Exposure level
Over write	On / Off	Cycle Recording
PIR Sensitivity	High/Medium/Low	Adjust PIR sensitivity
Language	EN/FR/DE/IT/ES/POR/HR/ DAN/SVE/SUO/POL/PYC	camera menu language
Transfer frequency	Each	N/L
Frequency	50HZ / 60HZ	Screen refresh rate
Camera ID	CAM000	6 numbers or letters
Password	On / Off	4 numbers
Working Timer	00:00:00 to 23:59:59	N/L
Date / Time	DD/MM/YY	N/L
Format	OK / Cancel	Format memory card
Default Setting	OK / Cancel	Back to default
Version		camera firmware version

SYSTEM UPGRAD

1).Click to the menu interface to open Network and select Check Update.

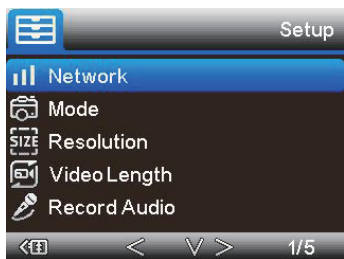

2).Check whether your machine is the latest version after opening.

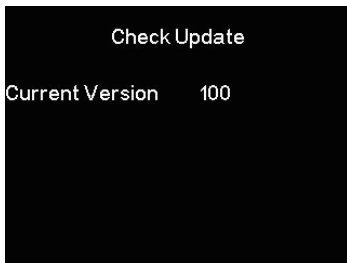

When the machine interface displays the current version and there is no prompt to update, it means it is now the latest version.

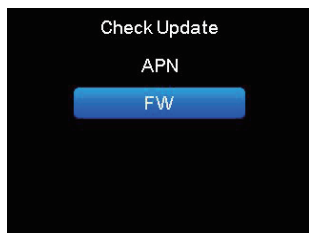
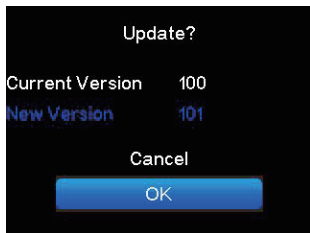

If the blue font New Version appears below the version number, you can choose to update or not to update. If you choose to update, you need to click FW to update.

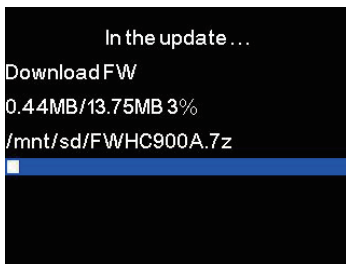

Wait until the progress bar reaches 100% and the upgrade is complete.

In The box



▲ Camera



▲ Manual



▲ Mounting Strap



▲ Card reader

TROUBLESHOOTING

Q: I want to use this camera, what do I need to prepare? how to setup ?

A: You only need to prepare a SIM card. (Please note that it must be a prepaid SIM card, closed PIN code,) Use your mobile phone to download our APP (SUNTEKCAM), use the APP to scan the camera's device ID, device name, you can fill in any name, device password 123456, then you can use it

Q: Is it possible to receive live images remotely?

A: This camera support video and image recording, but doesn't support Live video, another 4K model HC-900Pro support live video.

Model	Photo	Video (30fps)	Live Video	Cloud (free)	App (iOS & Android)	Remote Control	SMS	MMS	SMTP
HC-900Pro	36MP	4K	√	√	√	√	√	x	x
HC-900Plus	30MP	2K	x	√	√	√	√	x	x
HC-900LTE	20MP	1080P	x	x	x	x	√	√	√

Q: What kind of telephone operators do you support?

A: This camera support most of Europe sim card, if you are at U.S. and Canada, need to buy U.S. version, you can contact the seller for help..